

F&H GROUP A/S

DELIVERY INSTRUCTIONS

SEPTEMBER 2024

LOGISTICS COOPERATION BETWEEN F&H AND SUPPLIER

The purpose of this informative material is to establish transparent guidelines for delivery of goods to F&H's Warehouse and customers. Furthermore, to create a procedure to benefit all partners. F&H's customers have priority and therefore the handling of goods must be made as efficient as possible. The supplier guidelines will ensure the optimization of product handling and ensure delivery of the right product, right quantity, at the right time.

With these supplier instruction/guidelines, we will be able to reach our common goal. It is vital that all suppliers/personnel responsible for logistics are informed regarding the material. The guidelines will apply to all deliveries to F&H.



F&H is committed to maintaining sustainability of our supply chains. Ethical, social and environmental responsibility are integrated fundamentals of our long-term business strategy. We work closely with our suppliers and partners in attaining this goal. The above reflects the delivery guidelines.

If there are any questions regarding the guidelines described in the document, kindly contact the Logistics Department.

Ruddi Vestergaard Nielsen

Logistic Director

Tlf.: 2252 4710

Mail: RVN@FH-AS.DK

<http://www.fh-as.com/Suppliers/Supplier-guideline.aspx>

Contents

01 EUROPEAN SUPPLIERS GENERAL TERMS

- 1.1 Recommended box sizes. 5
- 1.2 Dimensions of the export carton . . 6
- 1.3 Outer carton 7
- 1.4 Carton quality 7
- 1.5 Plastic bags 8
- 1.6 Shipping marks 8
 - 1.6.1 Shipping marks for cartons 8
 - 1.6.2 Inner pack 9
 - 1.6.3 Outer pack 10
 - 1.6.4 Shipping mark location and size . 11
 - 1.6.5 Shipping marks for pallet box . . 12
- 1.7 Handling symbols. 13
 - 1.7.1 International handling symbols . . 13

02 DELIVERY ON PALLETS

- 2.1 Pallets. 14
 - 2.1.1 EUR pallets. 14
 - 2.1.2 Packing on pallets 15
 - 2.1.3 Wrapping guidelines 17
 - 2.1.4 Loading 17

03 GENERAL INFORMATION REQUIRED UPON SHIPMENT

- 3.1 General information 18
- 3.2 Information about shipment 18
- 3.3 Notification (prior to delivery). . . . 18

04 DETAIL INFORMATION

- Detail information 19

05 F&H TERMINAL INFORMATION

- F&H terminal information 20

06 CONTAINER SUPPLIERS GENERAL TERMS

- 6.1 Recommended box sizes. 22
- 6.2 Dimensions of the export carton . 23
- 6.3 Outer carton 24
- 6.4 Carton quality 24
- 6.5 Plastic bags 25
- 6.6 Shipping marks 25
 - 6.6.1 Shipping marks for cartons 25
 - 6.6.2 Inner pack 26
 - 6.6.3 Outer pack 27
 - 6.6.4 Shipping mark location and size . 28
 - 6.6.5 Shipping marks for pallet box . . 29
- 6.7 Handling symbols. 30
 - 6.7.1 International handling symbols . . 30

07 DELIVERY IN CONTAINER

- 7.1 Slip-sheets 31
 - 7.1.1 Slip-sheet – Description 31
 - 7.1.2 Slip-sheet workmanship 32
 - 7.1.3 General slip-sheet specifications. 33
 - 7.1.4 Slip-sheet dimensions 34

- 7.1.5 Packing of slip-sheets 34
- 7.1.6 Maximum height of slip-sheet . . . 35
- 7.1.7 Marking of slip-sheets 35
- 7.2 Containers 36
 - 7.2.1 Packing of a container 36
 - 7.2.2 Loading slip-sheets in container . 37
 - 7.2.3 Loading different products in the same container. 37
 - 7.2.4 Loading of loose cardboard cartons into container (correct method). 38
 - 7.2.5 F&H recommendation 39
 - 7.2.6 Reduction of moisture 40
 - 7.2.7 Types of drybags 41

08 GENERAL INFORMATION REQUIRED UPON SHIPMENT

- 8.1 General information 42
- 8.2 Information about shipment 42

09 DETAIL INFORMATION

- Detail information 43

01

EUROPEAN SUPPLIERS GENERAL TERMS

PLEASE MAKE SURE TO COMPLY WITH THESE REQUIREMENTS

- It is very important that you choose **a box size that proportionally** fit the EUR-pallet.
- The **maximum weight** of the cartons must not exceed **12 kg** GW.
- F&H only allows cardboard cartons, which fit the retail unit and allow **no further inner packages**.
- The international **handling symbols must be used if your products require special handling** during transport, at the warehouse or in the stores.
- Please ensure that each pallet only contains **one article number**.
- The maximum height for pallets is **135 cm** incl. pallet and a maximum weight of **500 kg**.
- The goods must be secured to the pallet, for stability, during transport. Wrapping with CLEAR foil is the preferred method of securing the goods. Please make sure the **shipping mark label can be seen** without splitting up the pallet.
- **F&H only accept EU-pallets (1/1 and ½ pallets) at our terminals.** F&H only accepts pallets in **perfect** condition, so that they can be reused throughout the F&H supply chain. **F&H does not allow invoicing of pallets that are not in perfect condition.**
- To ensure efficient communication a **complete shipping list** (See Delivery Instructions, page 18) must be **mailed** to the purchaser no later than **on the day of shipment**.
- All suppliers must announce the date of delivery of goods via mail: ankomstadv@fh-as.dk, no later than 12AM, and at least 24 hours prior to arrival, at F&H's terminals.

1.1 RECOMMENDED BOX SIZES

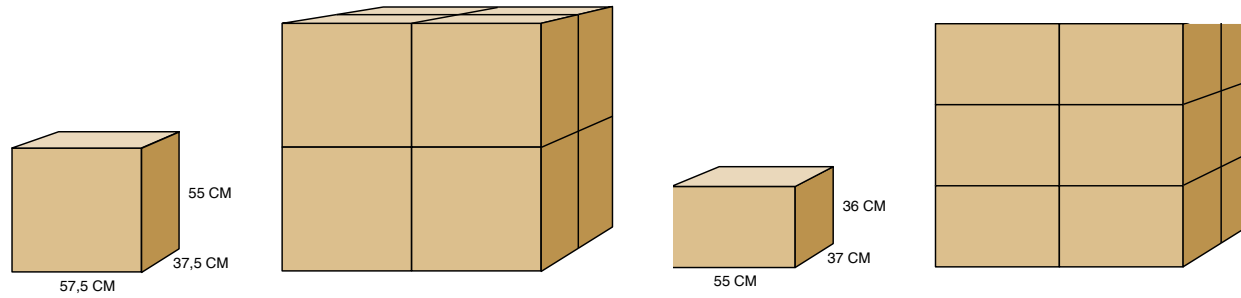

Figure 1: *Example-recommended box sizes.

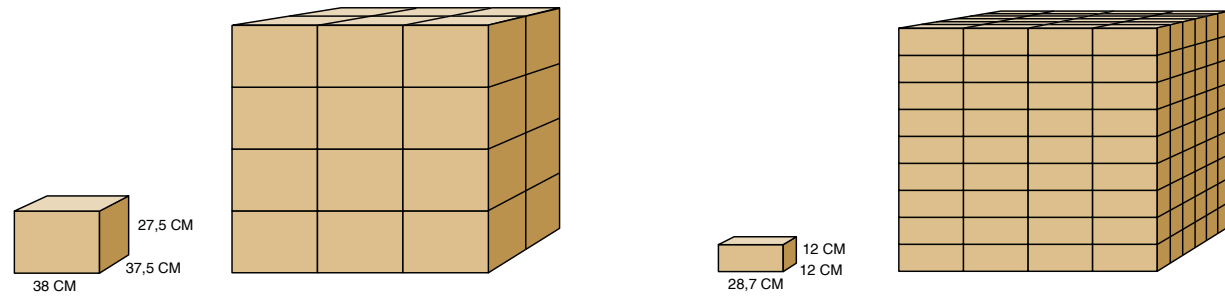

Figure 2: *Example-recommended box sizes.

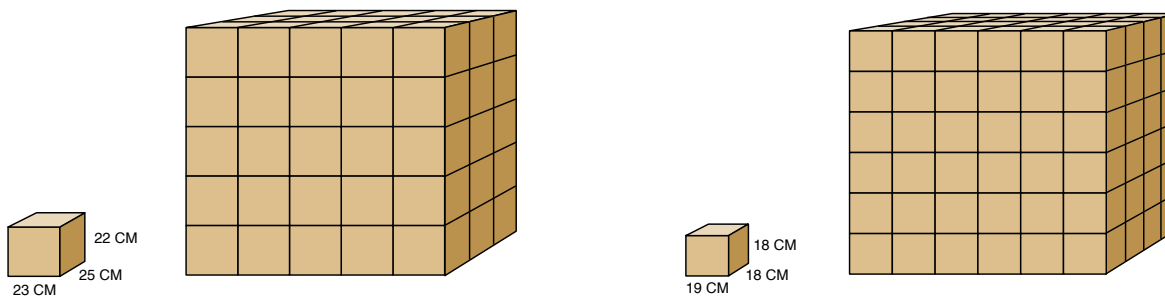
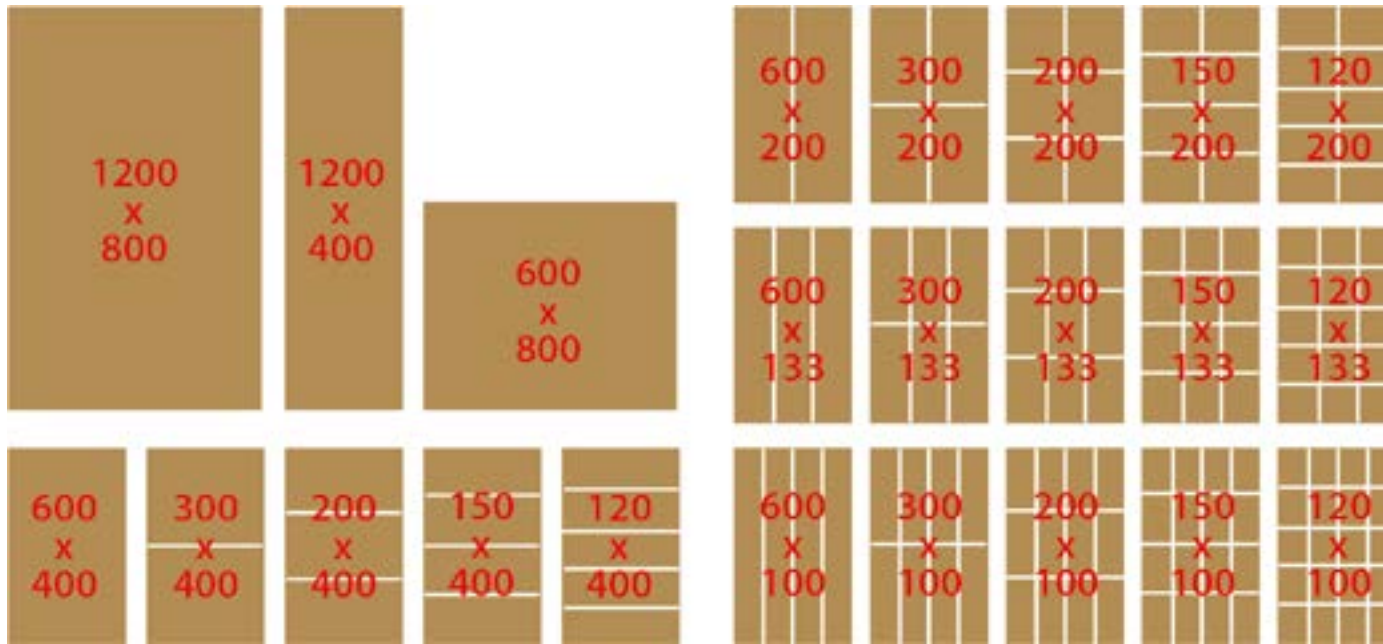

Figure 3: *Example-recommended box sizes.

*Notice how all the boxes shown corresponds with EU-pallet measurements (120 x 80cm) when packed together in the quantities shown above.

Suggestions and info on other types of boxes accepted by F&H can be found at www.iso.org. (ISO 3394)



If none of the boxes match, it's very important that you choose a box size that proportionally fit to the EUR pallet – 800 mm x 1200 mm.



MAX height for cartons stack on Pallet:
1350 mm incl. pallet.

1.2 DIMENSIONS OF THE EXPORT CARTON

This section describes the preferred dimensions for all goods delivered via Truck on pallets.

Important criteria for the dimension are that it must fit the goods. If the export carton is larger than the goods, the export carton will cave in the container/trailer and it will collapse during transportation. Therefore always make sure that the export carton is filled completely.

1.3 OUTER CARTON

The outer pack is used to protect the export goods adequately. All goods must be packed in protective cartons.

F&H only allows cardboard cartons, which fit the retail unit and we allow no further cardboard cartons between. If there are any deviations from this rule, it has to be separately approved by the Purchaser.

If the contents are sensitive to knives and other sharp objects, it must be clearly stated on the outside of the export carton as described in the section regarding handling symbols. To avoid possible damage to the product there should be laid an anti-cutting board in the top of the export carton.

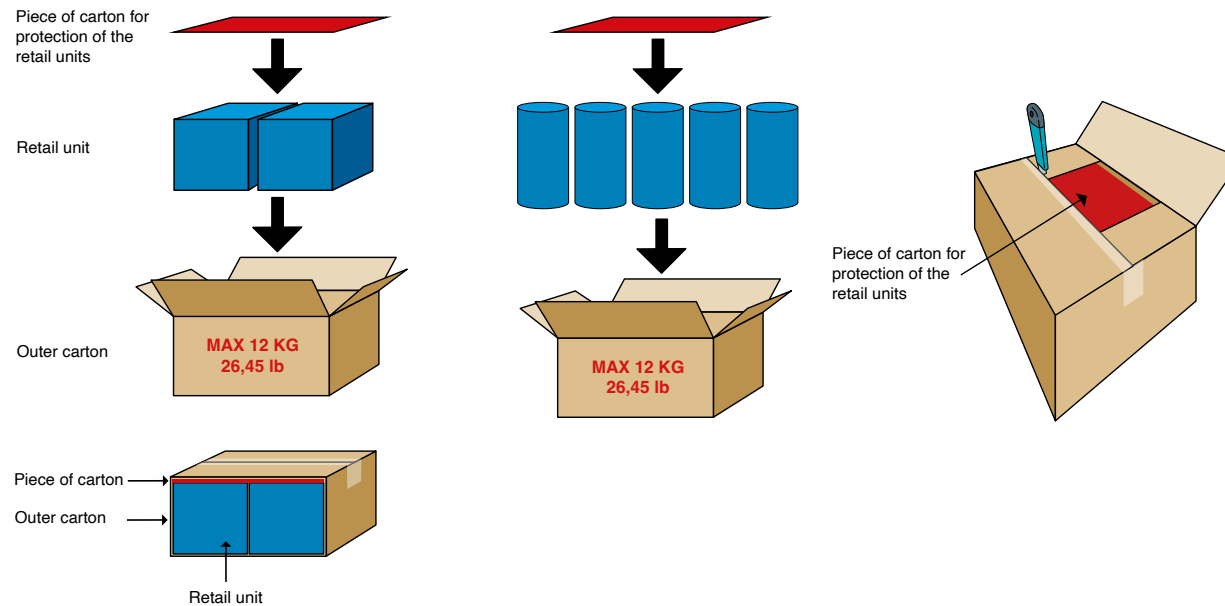

Figure 4: Outerpack Example – how protect goods for transportation and handling.

1.4 CARTON QUALITY

The corrugated carton box is most commonly used. It must be new cartons of such high quality that it remains stable during transportation.

Packaging must be of sufficient quality to support the weight of stacking the cartons up to a height of 2350 mm.

Cartons must not be wet or soggy as this will easily make the cartons break in transport.

Quality of export carton must be BC Flute 5 layer, or better.

1.5 PLASTIC BAGS

If the sales item is packed in a plastic bag and the opening in the plastic bag is larger than 17 cm, it's important there are holes in the plastic bag, and the following text is written on the plastic bag:

Warning in English

Plastic bags can be dangerous. Don't use in cots, prams, buggies, beds or playpens. The plastic bag may cling to the mouth and nose and prevent breathing. Keep children and babies away from plastic bag.

Warning in Danish

Plastikposer kan være farlige. For at undgå fare for kvælning, hold børn og babyer væk fra plastikposer.

Warning in Swedish

Plastpåsar kan vara farliga. För att undgå fara för kvälning, håll barn och bebisar borta från plastpåsar.

Warning in Norwegian

Plastikkposer kan være farlige. For å unngå fare for kvelning, hold barn og babyer unna plastikposer.

Warning in German

Plastiktüten können gefährlich sein. Halten Sie Kinder und Babys von Plastiktüten fern, um Erstickungsgefahr zu vermeiden.

1.6 SHIPPING MARKS

1.6.1 SHIPPING MARKS FOR CARTONS

When the consignment is delivered at F&H warehouse, it will be registered by means of barcode scanning. To ensure that the barcodes and labels can be registered it is very important that the below mentioned requirements for labels are followed.

The carton must be marked with the following text information and symbols. The text information can either be printed on the barcode label or directly on the carton.

A = Front and back of the box

B = Both sides of the box

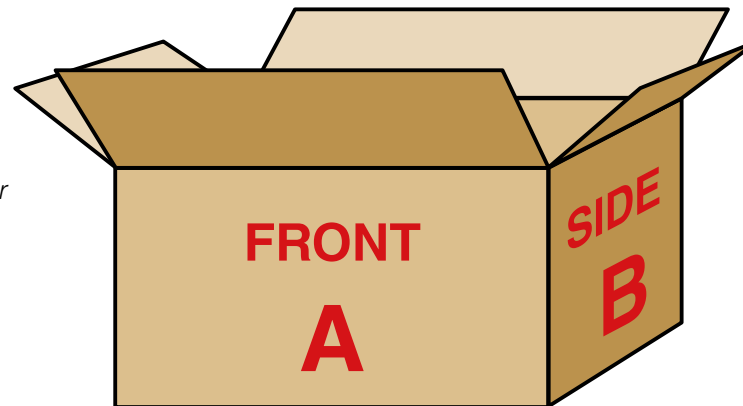



Figure 5: Where to mark the individual carton.



It is important that all 4 sides are marked with a barcode. This applies to each type of packaging the product is packed in. The barcode must be unique for each type of packaging.



1.6.2

<h1 style="margin: 0;">INNER PACK</h1> <p style="margin: 0;">First carton after retail unit</p>			
Front & Back (2 sides)	INFORMATION	DESCRIPTION	EXAMPLE
	Item no.	F&H Item no.	244470
	Order no.	F&H order no.	1602970
	Alternative 2 no.	Alt. item no – only if state by the purchaser	“Nothing specific”
	Description of article/ item	Description Cf. PO.	Margrethe Bowl 3,0l Warm white
	Quantity per carton	No. of sales units in the carton.	8
	Carton no.	1 / Up	1 / 53 cartons, 2 / 53 cartons etc.
	Imported by	F&H A/S	F&H A/S
	ITF-14	ITF-14 unique to package 1, on all 4 sides of the carton.	 <small>372200018364</small>
Sides (2 sides)	Size (L x B x H)	Carton Length x Width x Height Length = The longest horizontal measurement when carton is placed on pallet/ground Width = The shortest horizontal measurement when carton is placed on pallet/ground. Height=The vertical measurement when carton is placed on pallet/ground	
	Weight – netto	Carton net weight Weight without the carton = the total weight of the retail units in the carton	
	Weight – gross	Carton gross weight – MAX 12,00 kg	
	Made in	Country of origin	
	Item no.	F&H Item no.	244470
	Quantity per carton	No. of sales units in the carton.	8
	ITF-14	ITF-14 unique to package 1, on all 4 sides of the carton.	 <small>372200018364</small>

1.6.3

OUTER PACK (IF ALLOWED BY PURCHASING DEPARTMENT)

Second carton after retail unit (Contains inner pack)

Front & Back (2 sides)	INFORMATION	DESCRIPTION	EXAMPLE
	Item no.	F&H Item no.	244470
	Order no.	F&H order no.	1602970
	Alternative 2 no.	Alt. item no – only if state by the purchaser	“Nothing specific”
	Description of article/ item	Description Cf. PO.	Margrethe Bowl 3,0l Warm white
	Quantity per inner-/outer carton	No. of sales units in the carton.	8
	Carton no.	1 / Up	1 / 53 cartons, 2 / 53 cartons etc.
	Imported by	F&H A/S	F&H A/S
	ITF-14	ITF-14 unique to package 1, on all 4 sides of the carton.	
Sides (2 sides)	Size (L x B x H)	Carton Length x Width x Height Length = The longest horizontal measurement when carton is placed on pallet/ground Width = The shortest horizontal measurement when carton is placed on pallet/ground. Height=The vertical measurement when carton is placed on pallet/ground	
	Weight – netto	Carton net weight Weight without the carton = the total weight of the retail units in the carton	
	Weight – gross	Carton gross weight – MAX 12,00 kg	
	Made in	Country of origin	
	Item no.	F&H Item no.	244470
	Quantity per carton	No. of sales units in the carton.	8
	ITF-14	ITF-14 unique to package 1, on all 4 sides of the carton.	

1.6.4 SHIPPING MARK LOCATION AND SIZE

Labels should be at least 30 mm away from any edge as shown below and be labeled on of the carton. Text size has to be at least font 50 (at least 1 cm high).

There is no recommendation on label size as long as the text size is as stated above, however bigger is better.

Figure 6: Where- and how to mark the export carton.

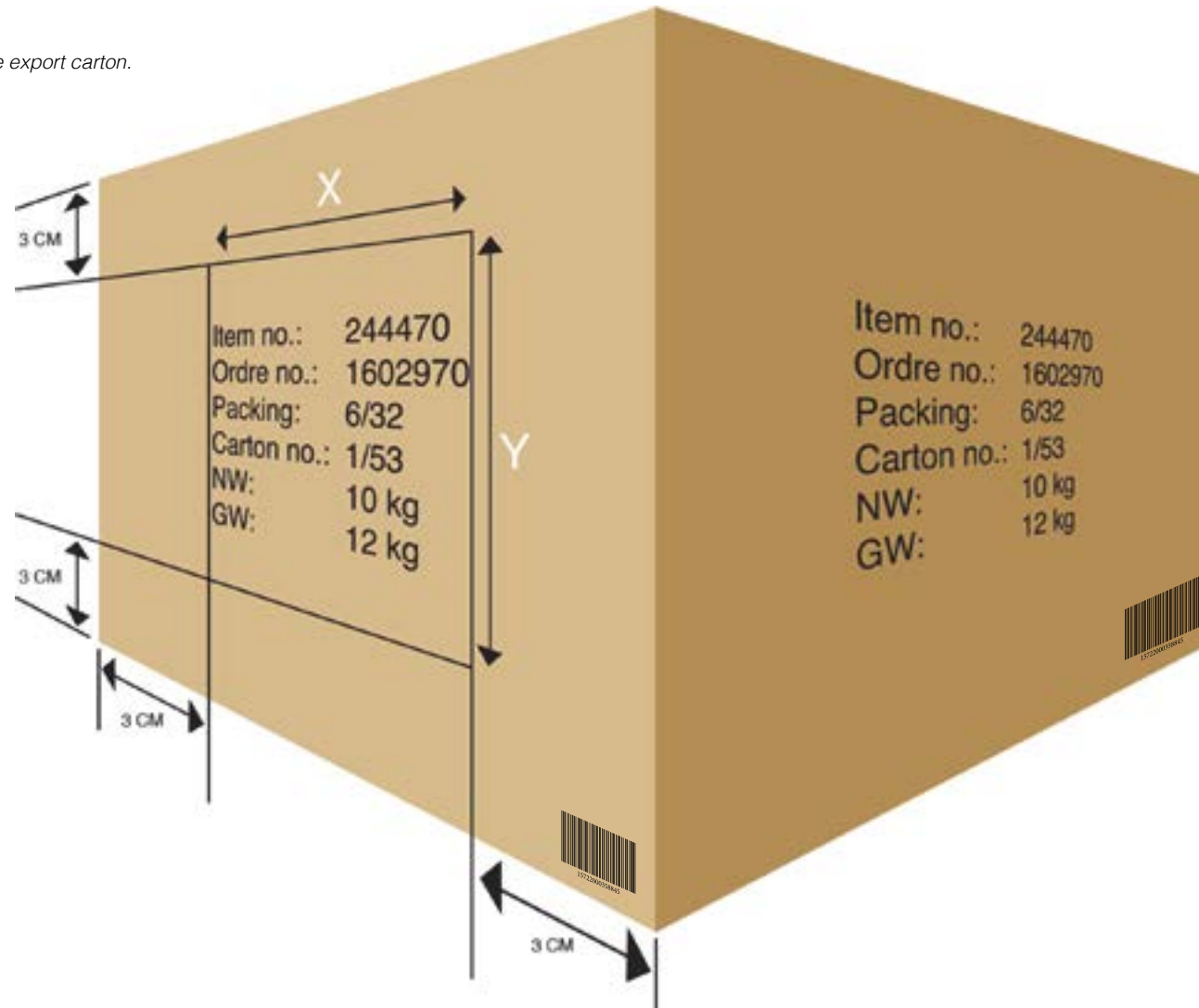

1.6.5 SHIPPING MARKS FOR PALLET BOX

INFORMATION	DESCRIPTION	EXAMPLE
Item No.:	F&H Item no.	244470
Order no.:	F&H order no.	1602970
Description of article/ item:	Description Cf. PO.	Margrethe Bowl 3,0l Warm white
Quantity of cartons:	No. of cartons on the pallet.	10
Quantity of product:	Total no. of retail units on the pallet.	80
Imported by:	F&H A/S	F&H A/S
Weight – netto	Pallet net weight Weight without the carton = the total weight of the retail units in the carton	175 kg
Weight – gross	Pallet gross weight – MAX 500,00 kg	205 kgf
Made in:	Country of origin	EN

The label is to be placed on each of the four sides of the pallet box and the minimum required size is A5 (210 x 148 mm).

Figure 7: The maximum dimensions of the pallet box and the placement of shipping marks.

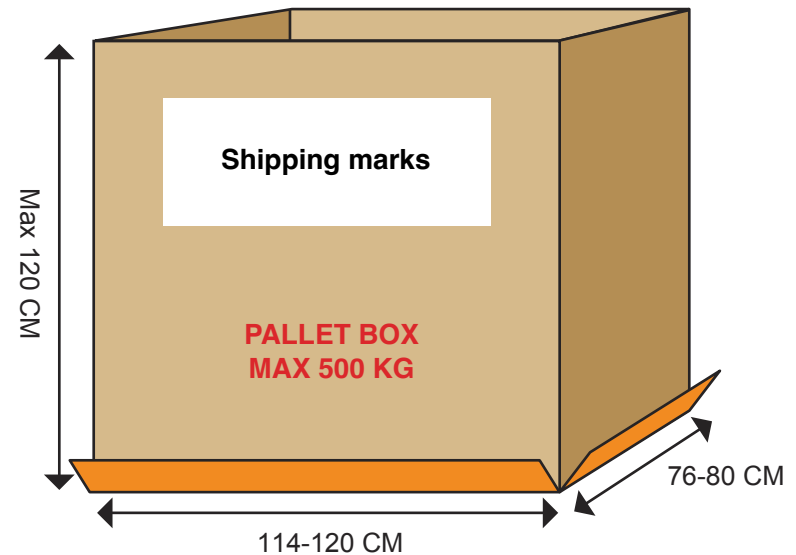

1.7 HANDLING SYMBOLS

In this section different handling symbols are described. Some are international and should be general knowledge to you and furthermore we also introduce you to the special handling symbols that we use.

1.7.1 INTERNATIONAL HANDLING SYMBOLS

These symbols are all international handling symbols and must be used if your products require special handling during transport, at the warehouses or in the stores. Make sure that the symbols are used only when required.







INFORMATION	DESCRIPTION
	Fragile – Handle with care
	Fragile – Handle with care - Glass
	<p>This side up. Symbol only to be used if:</p> <ol style="list-style-type: none"> Important for transport stability <ul style="list-style-type: none"> Direction has implication for stability due to the cartons ability to support the necessary weight (directional reinforcement in cartons) Important for product stability <ul style="list-style-type: none"> If product can be damaged/broken if packed in wrong direction
	Do not stack
	Maximum stack (shown here is “8”)
	Do not open with sharp object.

Figure 8: Example of handling symbols on export carton.

02



We only accept pallet that follows the international rules about ISPM 15

Example:



DELIVERY ON PALLETS

2.1 PALLETS

In this section it is described which pallets to be used for transportation of goods, when you deliver by truck.

2.1.1 EUR PALLETS

When you deliver our goods by truck use either EUR pallets or ½ EUR pallets. Please see the figure below. Pallets must be in perfect condition and heat treated.

The pallet size would therefore either be 800 mm (width) x 1200 mm (depth) or 800 mm (width) x 600 mm (depth).

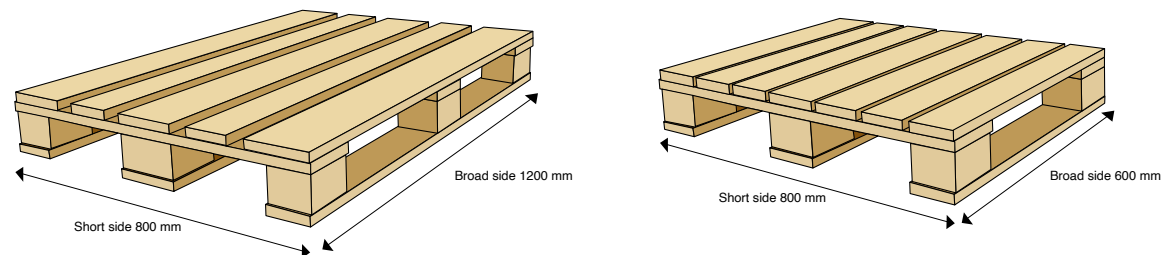

Figure 9: - EUR pallet and ½ EUR pallet.

2.1.2 PACKING ON PALLETS

- When goods are packed, please ensure that each pallet contains one F&H article number only in order to avoid sorting of goods upon receipt.
- The export carton/outer carton on the pallet must be kept within the pallet dimensions, at bottom as well as at the top, so that no carton exceeds the size of pallet/hangs outside pallet.
- The pallet must be packed in such a way that weight is distributed evenly across pallet – horizontally and vertically.
- The pallet has to be packed so that one row or the entire pallet will not collapse when removing the foil. Example using a joint-break arrangement (the boxes are fixed by their own weight)
- There must be protection on top and on corners.
- The shipping mark labels of all the boxes can be seen without splitting up the pallet.
- If ordered in layers, there must only be one product type per layer.

**NOTE: F&H does not allow invoicing of pallets that are not in perfect condition.
The illustration shown below shows a rough case.*

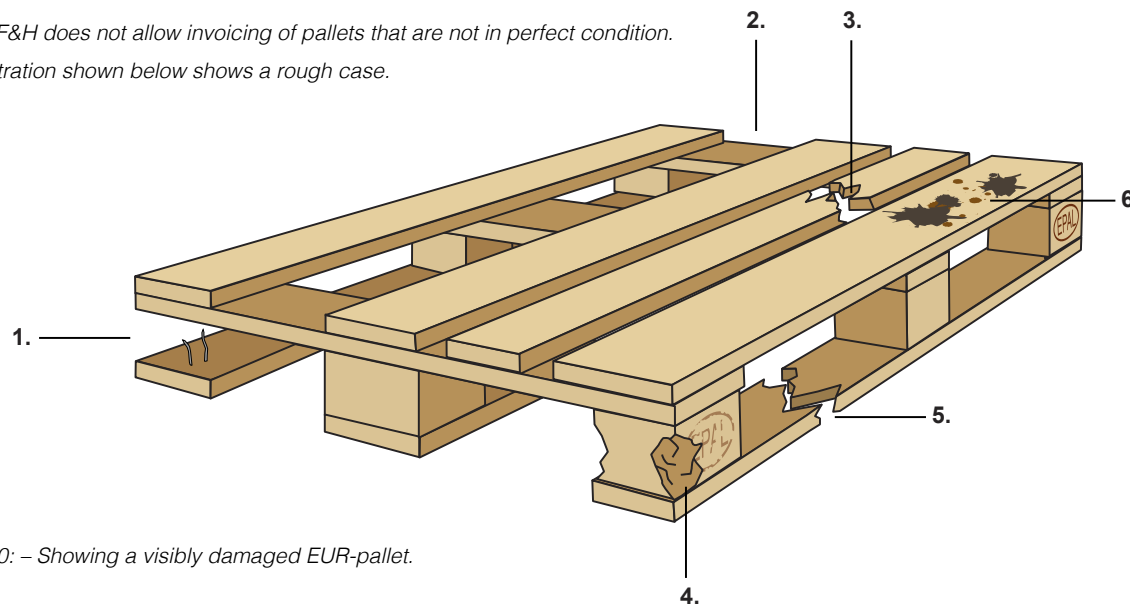

Figure 10: – Showing a visibly damaged EUR-pallet.



A pallet received at F&H terminals are expected to have ...

1. No missing skid blocks
2. No missing deck boards
3. No damage to any of the deck boards, no large splinters should be found either
4. No damage to any of the skid blocks
5. No damage to any of the stinger boards, no large splinters should be found either
6. No visible paint, spill damage or any sign of mold

PHOTOS BELOW SHOWING OPTIMAL WAYS TO PACK A PALLET

Figure 11: - Examples of a perfect way to pack a pallet, with the boxes in joint-break arrangement, for stability when foil is removed.

The pallets must also be packed to assure that no boxes weight more than 12 kg GW. If the weight is more than 12 kg GW, the Purchasers has to approve it.

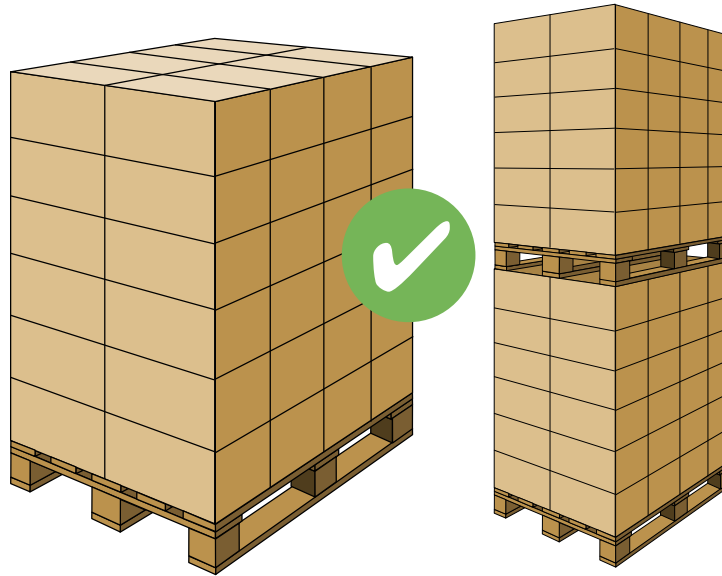

PHOTOS BELOW SHOWING HOW NOT TO PACK THE PALLETS

Figure 12: - Examples of poorly packed pallets.

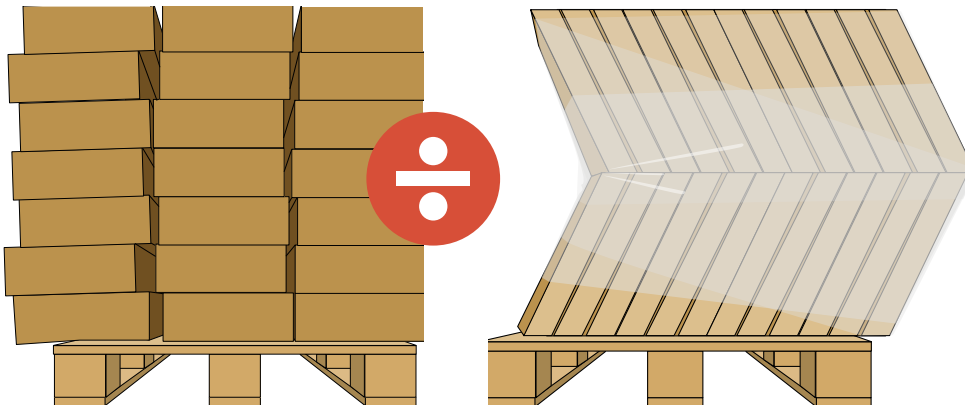

MAX height for cartons stack on EUR pallet: 135 cm incl. pallet

Absolute MAX weight per. pallet 500 kg GW

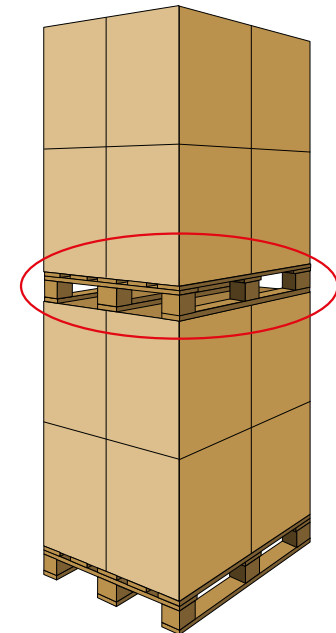

Figure 13: The individual pallet must never exceed 135cm in height, incl. the pallet. If goods are stackable stacking of pallets is allowed.

2.1.3 WRAPPING GUIDELINES

- The pallet is to be wrapped in CLEAR foil, to ensure stability during transport, as well as dust protection. Pallets must be wrapped individually.
- No individual wrapping of single export/ outer carton must be employed.
- No foil on the bottom of the pallet.
- No loose foil is allowed, the plastic must be properly secured. Securing foil around the pallet struts/joists is not allowed.



Figure 15: The foil should **NOT** in any way hinder handling or storage capabilities of the pallet



Figure 14: Individually wrapped pallet. The foil should **NOT** in any way hinder handling or storage capabilities of the pallet .

2.1.4 LOADING

If the pallets are delivered by truck, we only accept pallets loaded from the end of the truck:

The shipment will be rejected at F&H's terminals if this instruction is not followed.

Figure 16: Pallet short side must face the ends of the truck to be accepted at F&H's terminals.

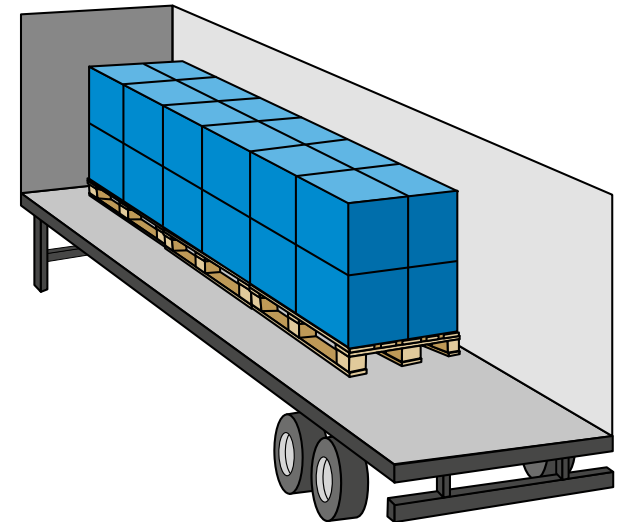

03

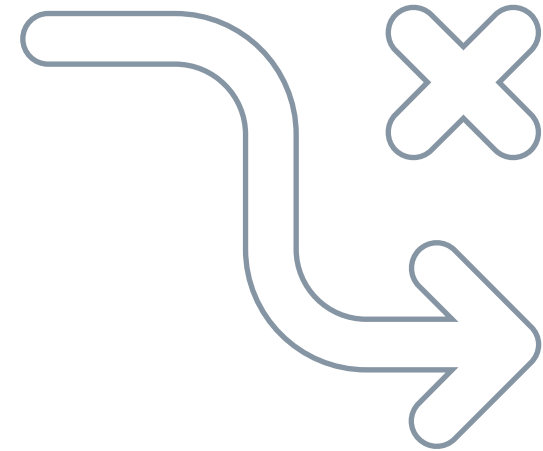

GENERAL INFORMATION REQUIRED UPON SHIPMENT

To ensure efficient communication between the supplier and F&H A/S, a complete shipping list must be mail to the Purchaser no later than on the day of shipment. The list must embed the following information:

3.1 GENERAL INFORMATION

1	F&H order number	
2	Container number	
3	Bill of lading number	
4	Name of vessel (ship)	
5	Date of departure	
6	Consignor/Shipper	
7	Consignor's/shipper's contact person	

3.2 INFORMATION ABOUT SHIPMENT

8	Total volume of shipment	
9	Total weight of shipment	
10	Total number of export cartons in shipment	
11	Delivered on pallets (Yes/no)? If yes no. of pallets	
12	Information about hazardous goods	

**The goods delivered pr. truckload must correspond with the supplied packing list.*

3.3 NOTIFICATION (PRIOR TO DELIVERY)

Info regarding (expected) time and date of delivery, at F&H's terminals, must be announced via: **ankomstadv@fh-as.dk, no later than 12AM, and at least 24 hours prior to arrival, at F&H's terminals.** If there are changes F&H must be notified immediately.

Any changes in date of delivery must be approved by F&H.

If our suppliers fail to notify F&H, F&H reserves the right to deny unloading the shipment until staff can be allocated to the task.

04

DETAIL INFORMATION

Purchaser will send a Microsoft excel document (looks like the one below).
The supplier is responsible to fill out the document and return it to the purchaser at least the day of shipment.

Figure 17: Master data document.

The packaging for the product must be divided into the different parts. Below are pictures with some examples showing the different parts.

For each packaging part a carton must be filled to the top. The top must be flat. Each carton is marked with a bar code. There must be labels between "Packaging part" (blue) and "Carton" (orange). "Packaging part" are the packaging parts that are covering the individual product, e.g. gift box covering for protection of the contents (see product). "Carton" are the packaging parts covering several products together. If a gift box is made of e.g. cardboard and plastic (like example 2 above), these two elements can be collectively described under "Packaging part". If a gift box is made entirely of cardboard and there is a support part made to hold the box, which is also made of cardboard, you cannot put these two together in "Packaging part". They must each have their own packaging part.

05



OPENING HOURS

MON-THURS
07.00-14.00

FRI
07.00-13.30

F&H TERMINAL INFORMATION

F&H MAIN TERMINAL

Industrivej 12
DK-8800 Viborg

**Use of terminal 2 and 3 is only relevant when agreed upon with F&H.*

F&H TERMINAL 2

Industrivej 29
DK-8800 Viborg

F&H TERMINAL 3

Farvervej 1
DK-8800 Viborg

06

CONTAINER SUPPLIERS GENERAL TERMS

PLEASE MAKE SURE TO COMPLY WITH THESE REQUIREMENTS

- It is very important that you choose a **box size that proportionally** fit the slip-sheet.
- The **maximum weight** of the cartons must not exceed **12 kg** GW.
- F&H only allows cardboard cartons, which fit the retail unit and allow **no further inner packages**.
- The international **handling symbols must be used if your products require special handling** during transport, at the warehouse or in the stores.
- When using slip-sheet, **use only new and unbroken sheets**, or boards made of coated carton, or plastic. **Make sure** the slip-sheet **flaps are accessible** (Unsealed and unstrapped) from the container door.
- Please ensure that each slip-sheet only contains **one article number**.
- The maximum height for slip-sheets is **120 cm** and a maximum weight of **500 kg**.
- The goods must be secured for stability, during transport. Wrapping with CLEAR foil is the preferred method of securing the goods. Please make sure the **shipping mark label can be seen** without splitting up the sheet.
- To ensure efficient communication a **complete shipping list** (See Delivery Instructions, page 43) must be mailed to the purchaser no later than **on the day of shipment**.

6.1 RECOMMENDED BOX SIZES

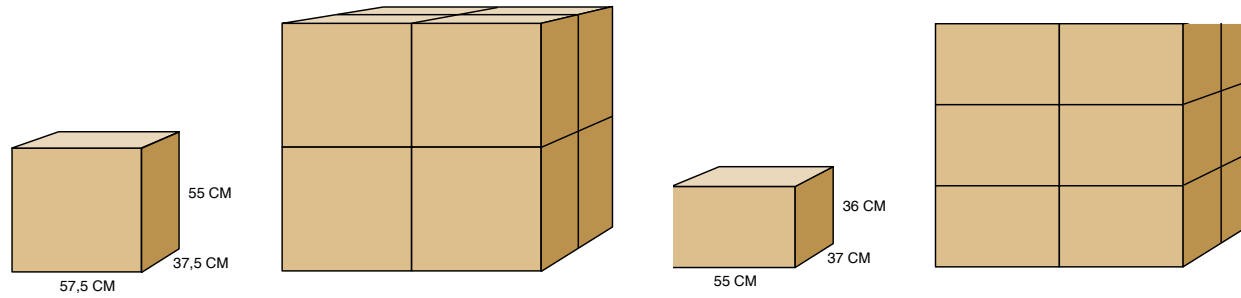

Figure 18: *Example-recommended box sizes.

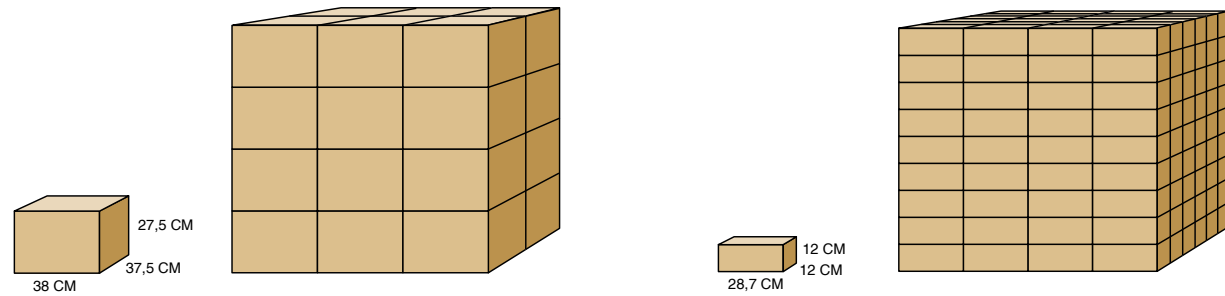

Figure 19: *Example-recommended box sizes.

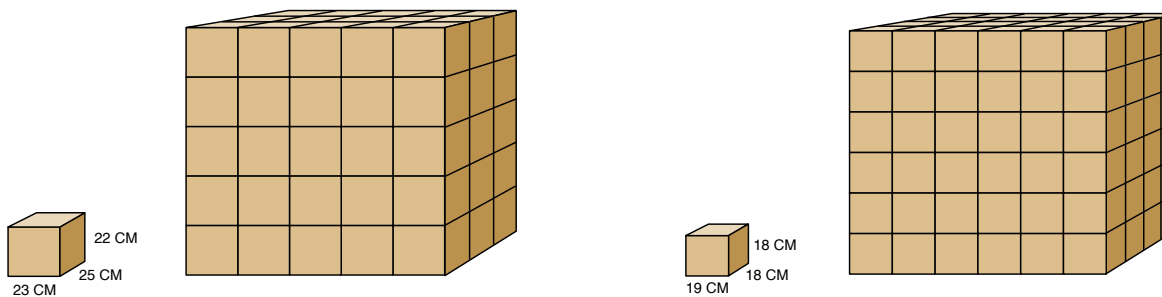
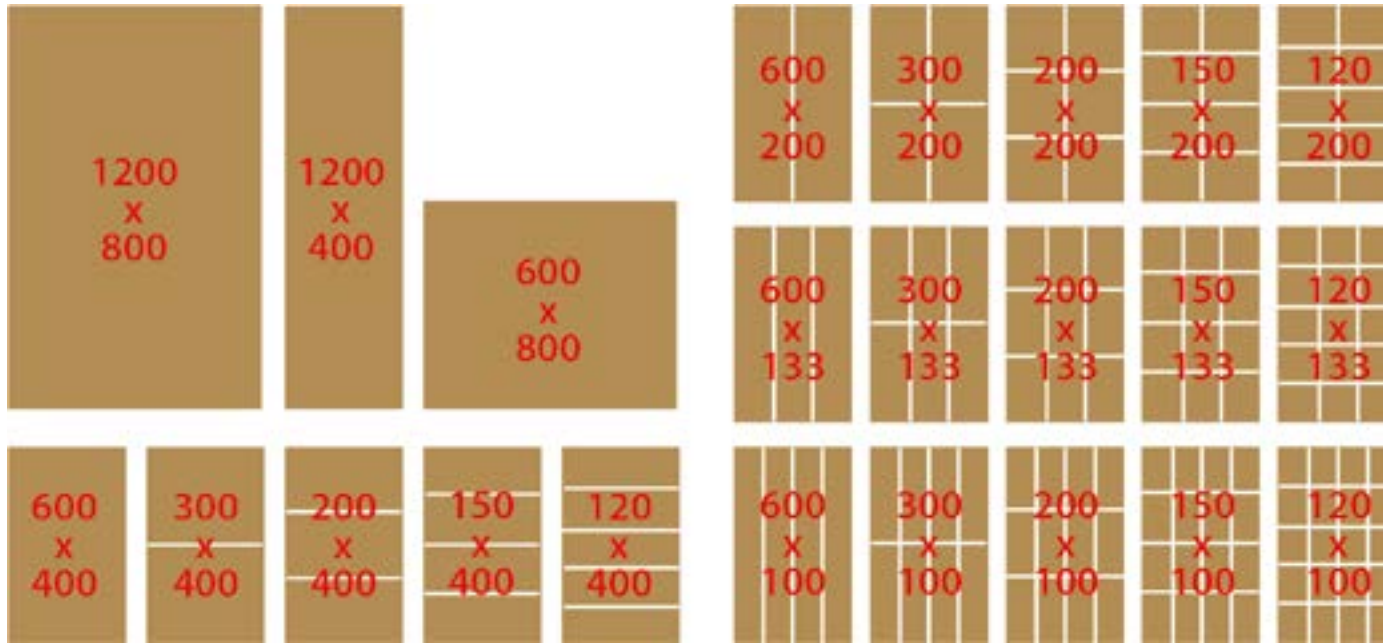

Figure 20: *Example-recommended box sizes.

*Notice how all the boxes shown corresponds with EU-pallet measurements (120 x 80cm) when packed together in the quantities shown above.

Suggestions and info on other types of boxes accepted by F&H can be found at www.iso.org. (ISO 3394)



!

If none of the boxes match, it's very important that you choose a box size that proportionally fit to the EUR pallet – 800 mm x 1200 mm.



**MAX height for cartons stack on Slip-sheet:
1200 mm**

6.2 DIMENSIONS OF THE EXPORT CARTON

This section describes the preferred dimensions for all goods delivered in a Container.

Important criteria for the dimension are that it must fit the goods. If the export carton is larger than the goods, the export carton will cave in the container, and it will collapse during transportation. Therefore, always make sure that the export carton is filled completely

6.3 OUTER CARTON

The outer pack is used to protect the export goods adequately. All goods must be packed in protective cartons.

F&H only allows cardboard cartons, which fit the retail unit and we allow no further cardboard cartons between. If there are any deviations from this rule, it has to be separately approved by the Purchaser.

If the contents are sensitive to knives and other sharp objects, it must be clearly stated on the outside of the export carton as described in the section regarding handling symbols. To avoid possible damage to the product there should be laid an anti-cutting board in the top of the export carton.

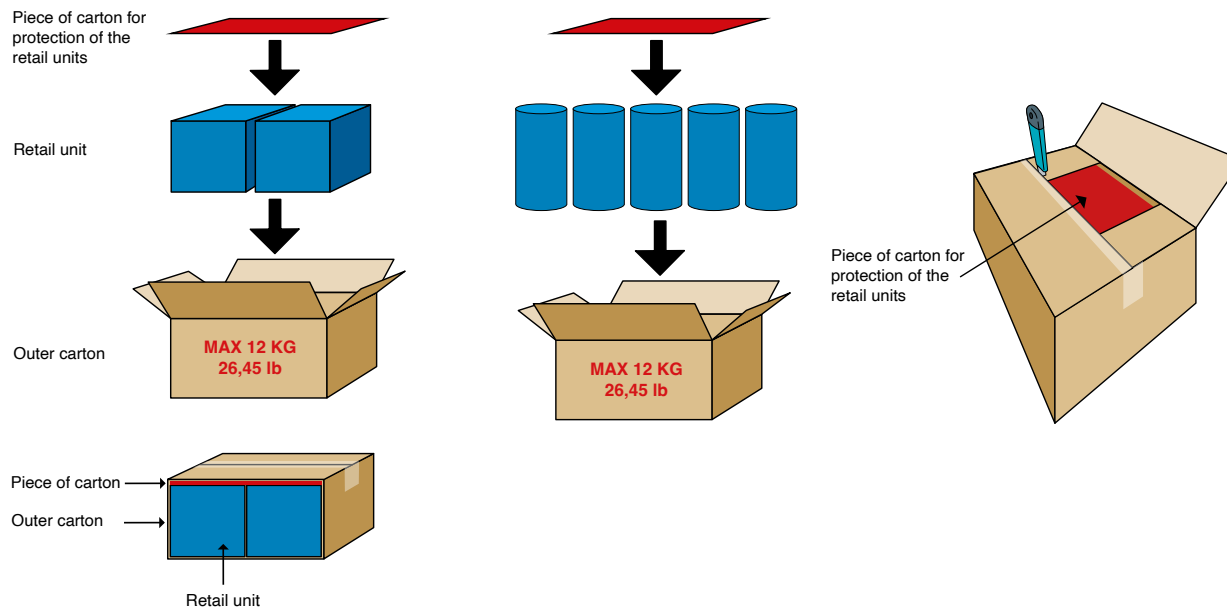

Figure 21: Outerpack Example – how protect goods for transportation and handling.

6.4 CARTON QUALITY

The corrugated carton box is most commonly used. It must be new cartons of such high quality that it remains stable during transportation.

Packaging must be of sufficient quality to support the weight of stacking the cartons up to a height of 2350 mm. Generally, a slip sheet stack may never be so high that it cannot support itself. This includes ensuring that the edge stiffness is sufficiently high.

Cartons must not be wet or soggy as this will easily make the cartons break in transport.

Quality of export carton must be BC Flute 5 layer, or better.

6.5 PLASTIC BAGS

If the sales item is packed in a plastic bag and the opening in the plastic bag is larger than 17 cm, it's important there are holes in the plastic bag, and the following text is written on the plastic bag:

Warning in English

Plastic bags can be dangerous. Don't use in cots, prams, buggies, beds or playpens. The plastic bag may cling to the mouth and nose and prevent breathing. Keep children and babies away from plastic bag.

Warning in Danish

Plastikposer kan være farlige. For at undgå fare for kvælning, hold børn og babyer væk fra plastikposer.

Warning in Swedish

Plastpåsar kan vara farliga. För att undgå fara för kvälning, håll barn och bebisar borta från plastpåsar.

Warning in Norwegian

Plastikkposer kan være farlige. For å unngå fare for kvelning, hold barn og babyer unna plastikposer.

Warning in German

Plastiktüten können gefährlich sein. Halten Sie Kinder und Babys von Plastiktüten fern, um Erstickungsgefahr zu vermeiden.

6.6 SHIPPING MARKS

6.6.1 SHIPPING MARKS FOR CARTONS

When the consignment is delivered at F&H warehouse, it will be registered by means of barcode scanning. To ensure that the barcodes and labels can be registered it is very important that the below mentioned requirements for labels are followed.

The carton must be marked with the following text information and symbols. The text information can either be printed on the barcode label or directly on the carton.

A = Front and back of the box

B = Both sides of the box

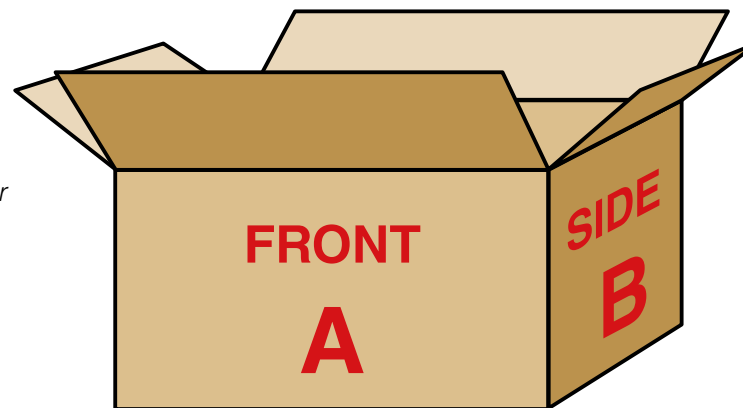



Figure 22: Where to mark the individual carton.



It is important that all 4 sides are marked with a barcode. This applies to each type of packaging the product is packed in. The barcode must be unique for each type of packaging.



6.6.2

<h1 style="margin: 0;">INNER PACK</h1> <p style="margin: 0;">First carton after retail unit</p>			
Front & Back (2 sides)	INFORMATION	DESCRIPTION	EXAMPLE
	Item no.	F&H Item no.	244470
	Order no.	F&H order no.	1602970
	Alternative 2 no.	Alt. item no – only if state by the purchaser	“Nothing specific”
	Description of article/ item	Description Cf. PO.	Margrethe Bowl 3,0l Warm white
	Quantity per carton	No. of sales units in the carton.	8
	Carton no.	1 / Up	1 / 53 cartons, 2 / 53 cartons etc.
	Imported by	F&H A/S	F&H A/S
	ITF-14	ITF-14 unique to package 1, on all 4 sides of the carton.	 <small>13722000318364</small>
Sides (2 sides)	Size (L x B x H)	Carton Length x Width x Height Length = The longest horizontal measurement when carton is placed on pallet/ground Width = The shortest horizontal measurement when carton is placed on pallet/ground. Height=The vertical measurement when carton is placed on pallet/ground	
	Weight – netto	Carton net weight Weight without the carton = the total weight of the retail units in the carton	
	Weight – gross	Carton gross weight – MAX 12,00 kg	
	Made in	Country of origin	
	Item no.	F&H Item no.	244470
	Quantity per carton	No. of sales units in the carton.	8
	ITF-14	ITF-14 unique to package 1, on all 4 sides of the carton.	 <small>13722000318364</small>

6.6.3

OUTER PACK (IF ALLOWED BY PURCHASING DEPARTMENT)

Second carton after retail unit (Contains inner pack)

Front & Back (2 sides)	INFORMATION	DESCRIPTION	EXAMPLE
	Item no.	F&H Item no.	244470
	Order no.	F&H order no.	1602970
	Alternative 2 no.	Alt. item no – only if state by the purchaser	“Nothing specific”
	Description of article/ item	Description Cf. PO.	Margrethe Bowl 3,0l Warm white
	Quantity per inner-/outer carton	No. of sales units in the carton.	6/32
	Carton no.	1 / Up	1 / 53 cartons, 2 / 53 cartons etc.
	Imported by	F&H A/S	F&H A/S
	ITF-14	ITF-14 unique to package 1, on all 4 sides of the carton.	
Sides (2 sides)	Size (L x B x H)	Carton Length x Width x Height Length = The longest horizontal measurement when carton is placed on pallet/ground Width = The shortest horizontal measurement when carton is placed on pallet/ground. Height=The vertical measurement when carton is placed on pallet/ground	
	Weight – netto	Carton net weight Weight without the carton = the total weight of the retail units in the carton	
	Weight – gross	Carton gross weight – MAX 12,00 kg	
	Made in	Country of origin	
	Item no.	F&H Item no.	244470
	Quantity per carton	No. of sales units in the carton.	8
	ITF-14	ITF-14 unique to package 1, on all 4 sides of the carton.	

6.6.4 SHIPPING MARK LOCATION AND SIZE

The shipping marks should be at least 30 mm away from any edge as shown below and be labelled on **at least 2 opposite sides** of the carton. Text size has to be at least font 50 (at least 1 cm high).

There is no recommendation on the size as long as the text size is as stated above, however bigger is better.

Figure 6: Where- and how to mark the export carton.

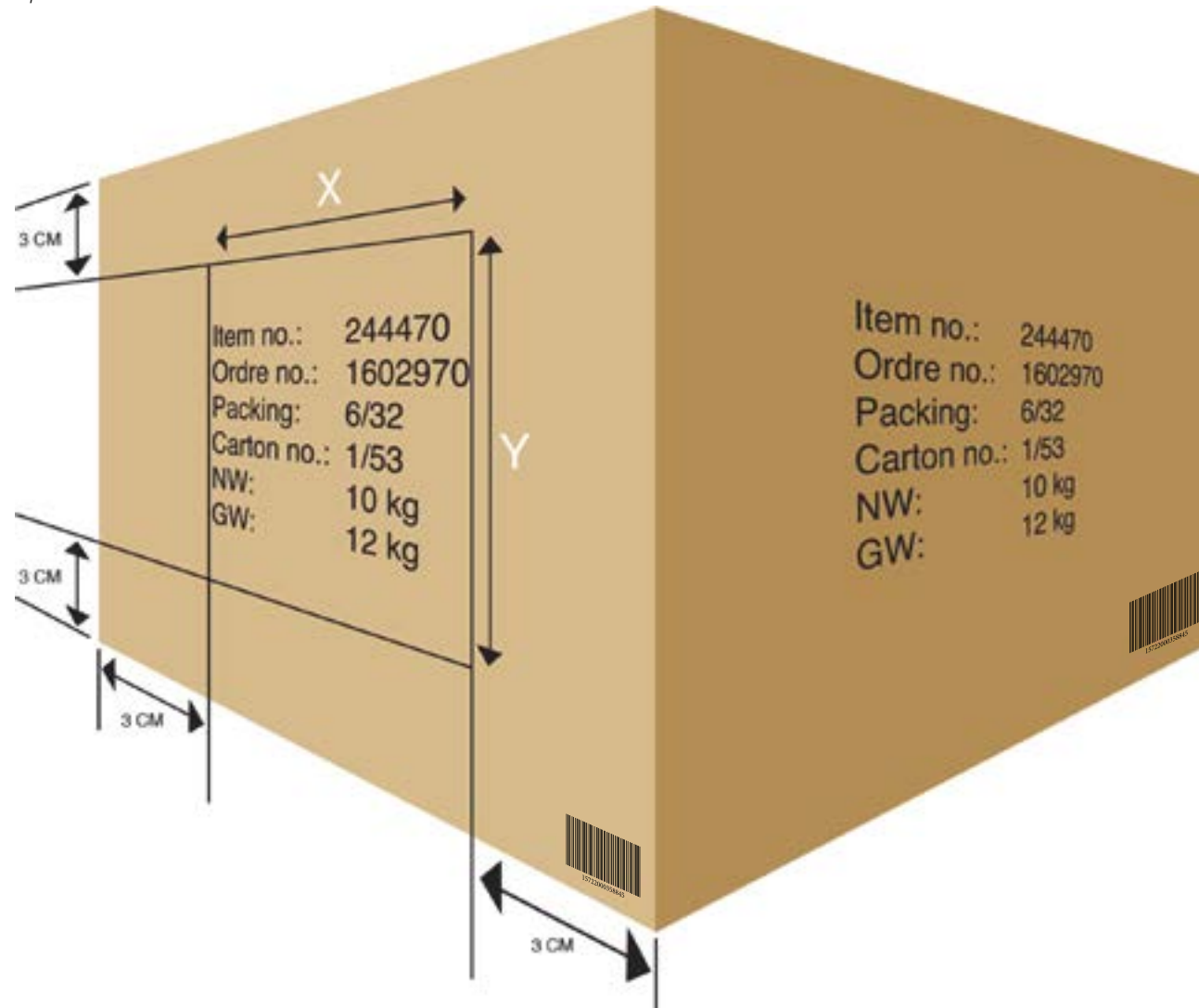

6.6.5 SHIPPING MARKS FOR PALLET BOX

INFORMATION	DESCRIPTION	EXAMPLE
Item No.:	F&H Item no.	244470
Order no.:	F&H order no.	1602970
Description of article/ item:	Description Cf. PO.	Margrethe Bowl 3,0l Warm white
Quantity of cartons:	No. of cartons on the slip-sheet.	10
Quantity of product:	Total no. of retail units on the slip-sheet.	80
Imported by:	F&H A/S	F&H A/S
Weight – netto	Slip-sheet net weight Weight without the carton = the total weight of the retail units in the carton	175 kg
Weight – gross	Slip-sheet gross weight – MAX 500,00 kg	205 kg
Made in:	Country of origin	CN

The label is to be placed on each of the four sides of the pallet box and the minimum required size is A5 (210 x 148 mm).

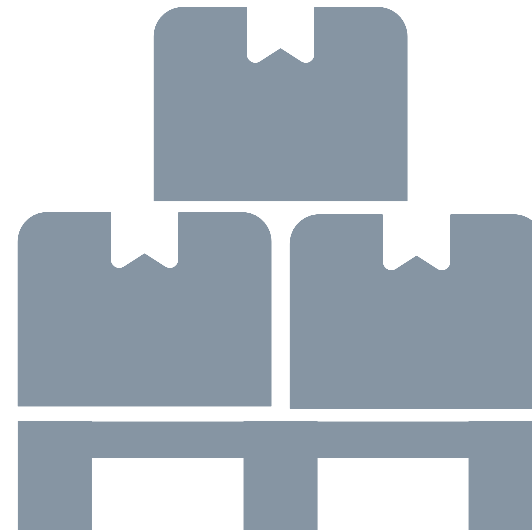

6.7 HANDLING SYMBOLS

In this section different handling symbols are described. Some are international and should be general knowledge to you and furthermore we also introduce you to the special handling symbols that we use.

6.7.1 INTERNATIONAL HANDLING SYMBOLS

These symbols are all international handling symbols and must be used if your products require special handling during transport, at the warehouses or in the stores. Make sure that the symbols are used only when required.







INFORMATION	DESCRIPTION
	Fragile – Handle with care
	Fragile – Handle with care - Glass
	<p>This side up. Symbol only to be used if:</p> <ol style="list-style-type: none"> Important for transport stability <ul style="list-style-type: none"> Direction has implication for stability due to the cartons ability to support the necessary weight (directional reinforcement in cartons) Important for product stability <ul style="list-style-type: none"> If product can be damaged/broken if packed in wrong direction
	Do not stack
	Maximum stack (shown here is “8”)
	Do not open with sharp object.

Figure 7: Example of handling symbols on export carton.

DELIVERY IN CONTAINER

7.1 SLIP-SHEETS

In this section it is described how you must use slip-sheets for transportation of goods delivered in containers.

7.1.1 SLIP-SHEET – DESCRIPTION

A slip-sheet is a sheet or board made of coated carton or plastic. When loading and unloading containers, the slip-sheets are handled by a normal fork-lift truck, with a special slip-sheet device or roller forks mounted.

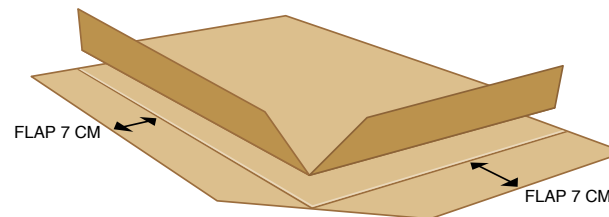
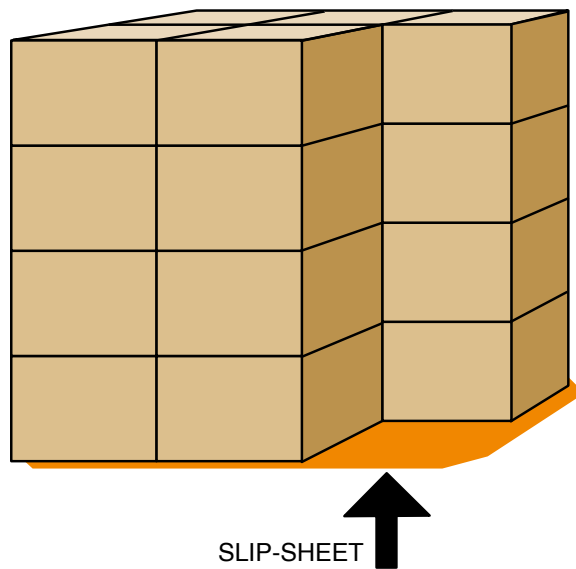

Figure 23: Slip-sheet.

7.1.2 SLIP-SHEET WORKMANSHIP

- Strictly no reused/recycled slip-sheets are allowed. Only new slip-sheets must be used.
- Slip-sheets must not be wet, soggy or torn.
- Slip-sheets must not be dirty or stained.
- Always store slip-sheets in dry places, but never on bare floors.
- All slip-sheets shall have NO printings, and strictly no writings allowed on slip-sheets.
- Do not exceed the manufacturer's maximum recommended load per slip-sheet. F&H allows max of ½ ton (500 kg.) load per slip-sheet.
- Creasing lines on the flaps must not be broken or torn; otherwise, the flap will be torn apart when pulled.



Always store slip-sheets in dry places, but never on bare floors.

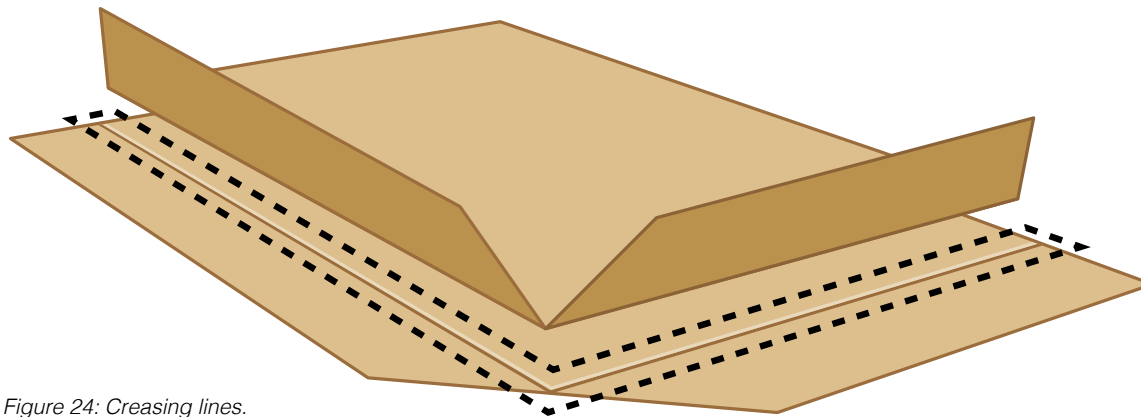

Figure 24: Creasing lines.

7.1.3 GENERAL SLIP-SHEET SPECIFICATIONS

- The strength of the slip-sheet is very important. Make sure that the Slip-sheet is stable enough to carry the goods. For most products a slip-sheet made of coated carton can be used but for very heavy products a slip-sheet made of plastic must be used.
- The slip-sheet must be stable enough to endure the transportation, as well as being handled after the transportation.
- If you have any questions regarding slip-sheets, you are very welcome to contact our office in Guangzhou on phone +86-20-89048075.

Or contact the manufacturer, ex.:

建议可选择的包材供方

Item Name	Quality Standard	Suggested supplier
Slip sheet	1) 国产玖龙 (牛皮纸) 2) 厚度 0.9mm 3) 相邻两边折边: 7cm	可通过网上下单 http://jytpzzhipin.1688.com/page/feedback.htm?spm=a2615.7691478.0.0.R89YpF 叶先生 Tel:13590396363 hjt1982@126.com
Plastic lock	白色塑料	Mary Tel: 13599688224 marycompany@163.com
Protect net	1) 白色涤纶 2) 绳粗 6mm, 网格 15cmX15cm 3) 尺寸要求: 20'GP/40'GP: 2.3M(W)x2.3M(L) : RMB30 40'HQ: 2.3M(W)x2.6M(L): RMB30 注: 以上价格不含运费	陈小姐 Tel:13380103784 77398266@qq.com
Dry bag in container	Super Dry 1Kg/bag 6 bags/20'GP 10 bags/ 40'GP or 40'HQ	Fanny Fan / 范丽聪 Customer Service Specialist / 跟单客服 Office: +86 755 - 8474 6912 Mobile: +86 136 8232 1895 Email: fanny@superdryers.com.cn
Slip sheet load calculation	http://www.onpallet.com/index.php	

7.1.4 SLIP-SHEET DIMENSIONS

EU pallet dimension – Top priority

(120 x 80 cm)

Cardboard cartons must, as top priority, be stacked on slip-sheet to meet EU pallet dimension (surface area) of 120 x 80 cm with a maximum weight of 500 kg. At F&H, all goods are stored on EU pallets that fit the shelving systems.

Figure 25: The dimensions of a slip-sheet.

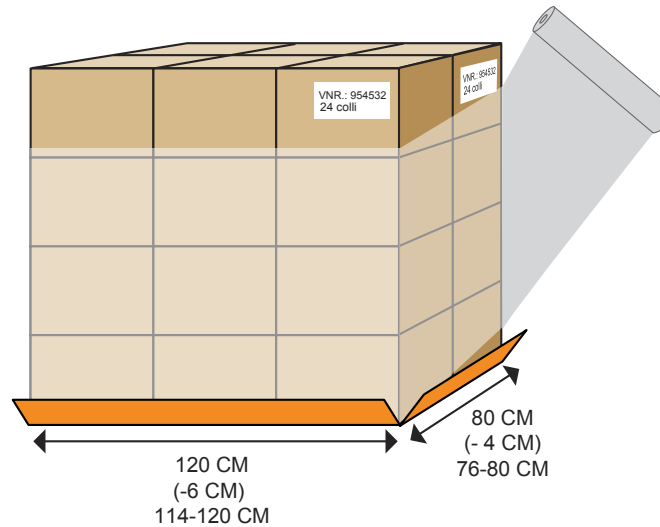

It is highly recommended that cardboard cartons can be stacked to an EU pallet dimension of 120 (-6) cm x 80 (-4) cm

7.1.5 PACKING OF SLIP-SHEETS

To fit the EU pallet dimension, cardboard cartons can be horizontally stacked in the middle as shown below.

Only one article number per slip-sheet.

It is important to use a sufficient amount of wrapping, to prevent boxes coming loose during transport.

DO NOT wrap the flaps. Slip-sheet flaps must remain loose/open at all time, otherwise it serves no purpose.

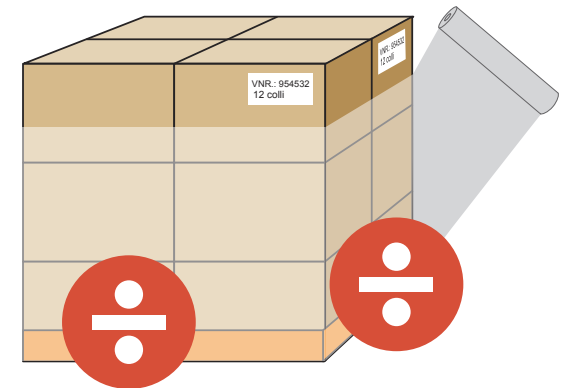
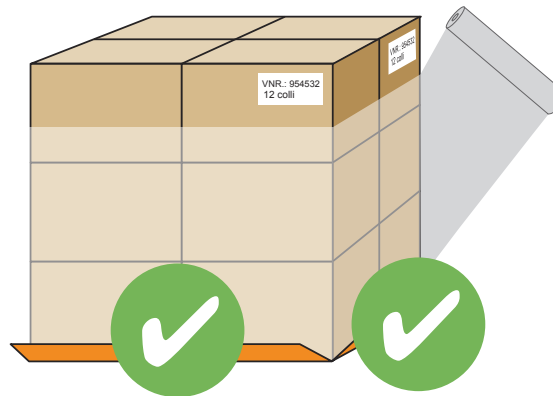

Figure 26: Slip-sheet – notice the freefloating flaps used for handling.

7.1.6 MAXIMUM HEIGHT OF SLIP-SHEET

F&H requires the export cartons to be stacked on slip-sheet - only one item number per slip-sheet. This must be the top priority without compromise (See figure below).

The maximum height for cardboard cartons stacked in 1 slip-sheet is 120 cm high. The goods should be stacked as close to the max height as possible, without exceeding the limit.

Figure 27: How to stack goods packed on slipsheets.
Notice max height pr. Slip-sheet.

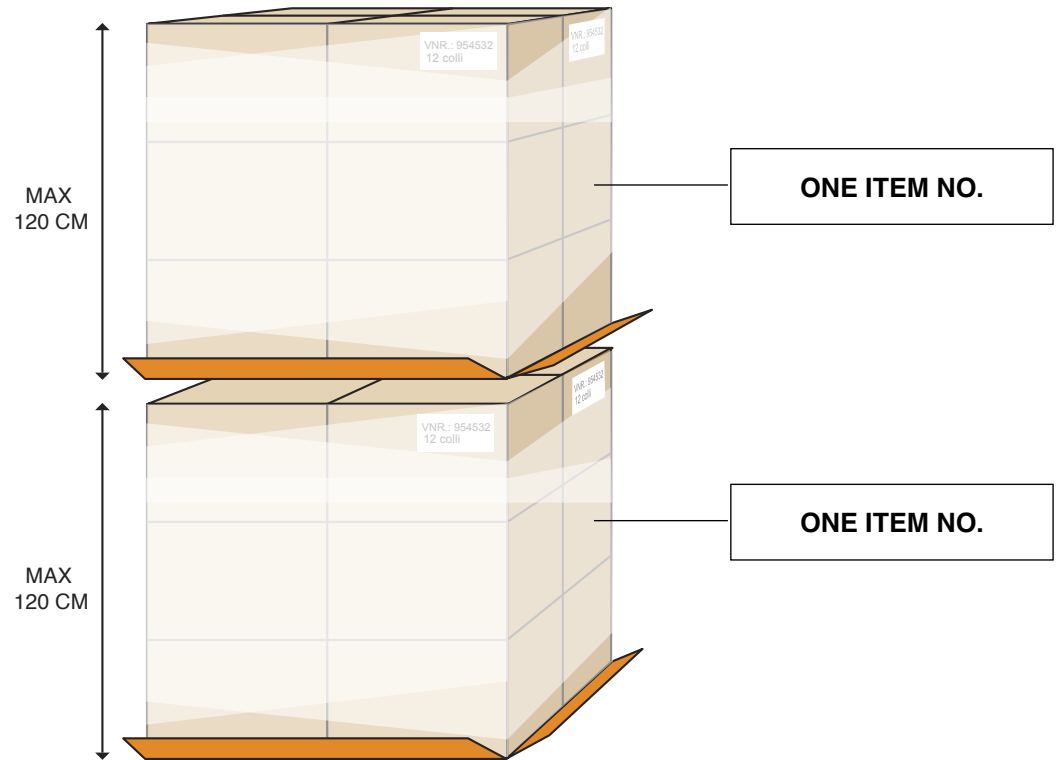
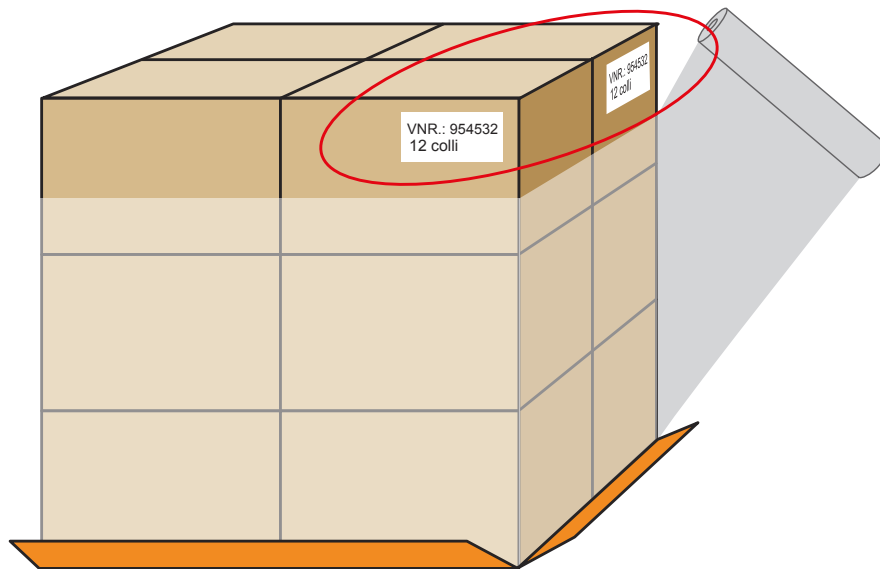

7.1.7 MARKING OF SLIP-SHEETS

Each slip-sheet must be marked with item No. and the number of cartons on the sheet.

Figure 28: How to mark each slip-sheet.

7.2 CONTAINERS

In this section F&H wants to describe how we want you to stow the goods into the containers.

7.2.1 PACKING OF A CONTAINER

In order to prevent damaged cartons and to facilitate the handling during receipt at our warehouse, it is important to arrange the packing of the container as follows:

When slip-sheets are used in the container, it is important to have free space between top of the goods and the container ceiling so the goods can be unloaded by means of a fork-lift truck (see picture below).

Figure 31: How to pack a container with slip-sheets.

Container rear door



Slip-sheet flaps must always face the door.
Slip-sheet flaps must NEVER be wrapped with plastic or strapped.

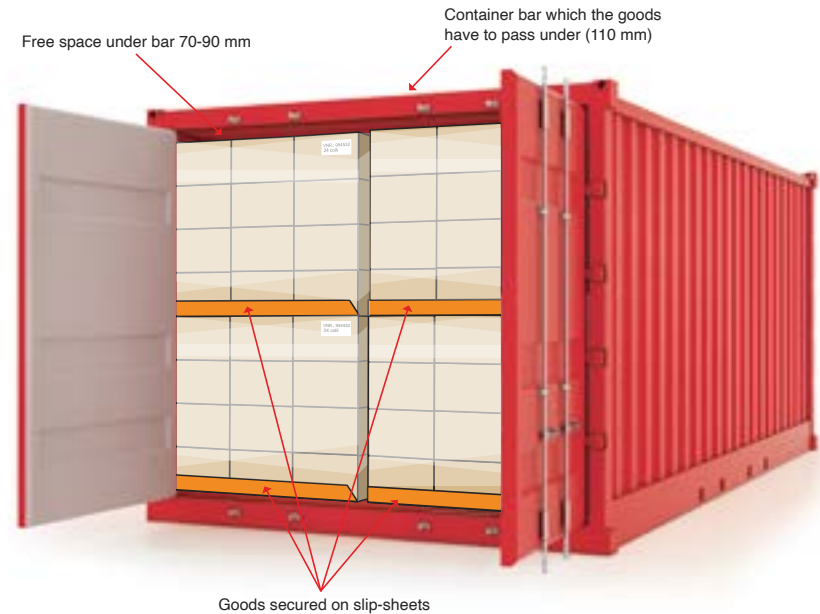

Figure 32: How to pack a container with slip-sheets.

When loading slip-sheets into containers, the flaps must always face the container door as shown below. Flaps must not be sealed or strapped.

7.2.2 LOADING SLIP-SHEETS IN CONTAINER

When loading the container with slip-sheets, the correct loading pattern is 3-2-3, as shown below. This adds to the stability of the goods during transport.

Figure 33: Top view of a container packed with slip-sheets.
Notice the 3-2-3 pattern.

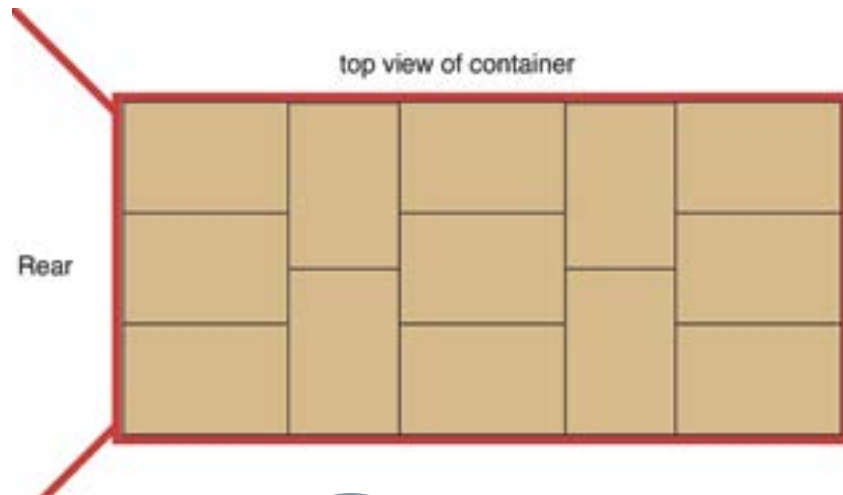

Make sure that heavier items are always placed on the floor of the container.

7.2.3 LOADING DIFFERENT PRODUCTS IN THE SAME CONTAINER

If there is more than one F&H item number in the container, you may not mix the products in the container. The products have to be organized in the container, shown as below. F&H only allows one item number one each slip-sheet.

Figure 34: Top view of a container packed with 3 different items.

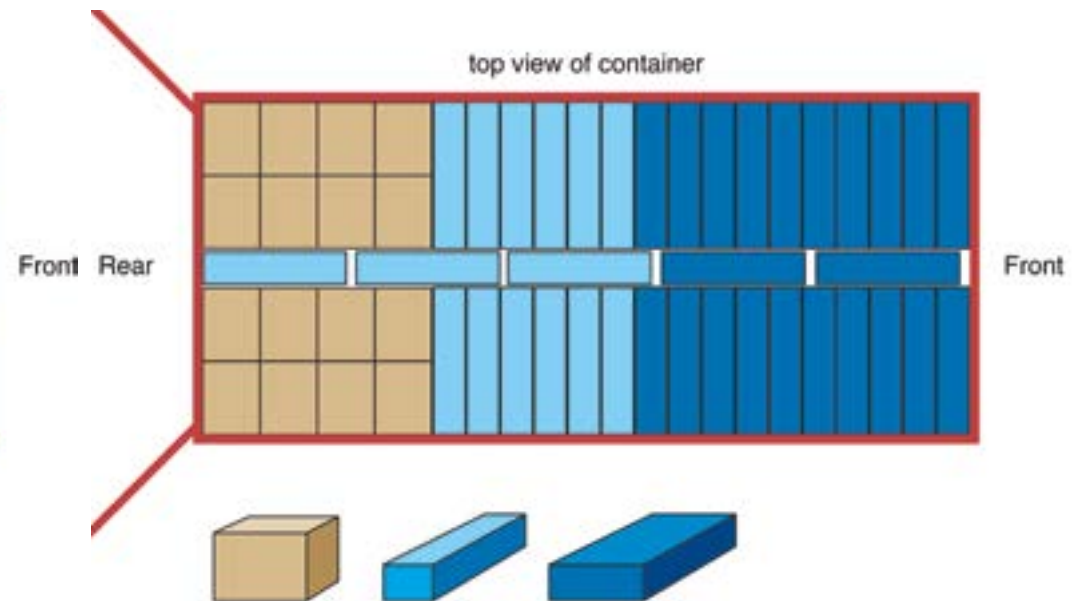

7.2.4 LOADING OF LOOSE CARDBOARD CARTONS INTO CONTAINER (CORRECT METHOD)

Figure 35: Example - how to load and stack loose cartons

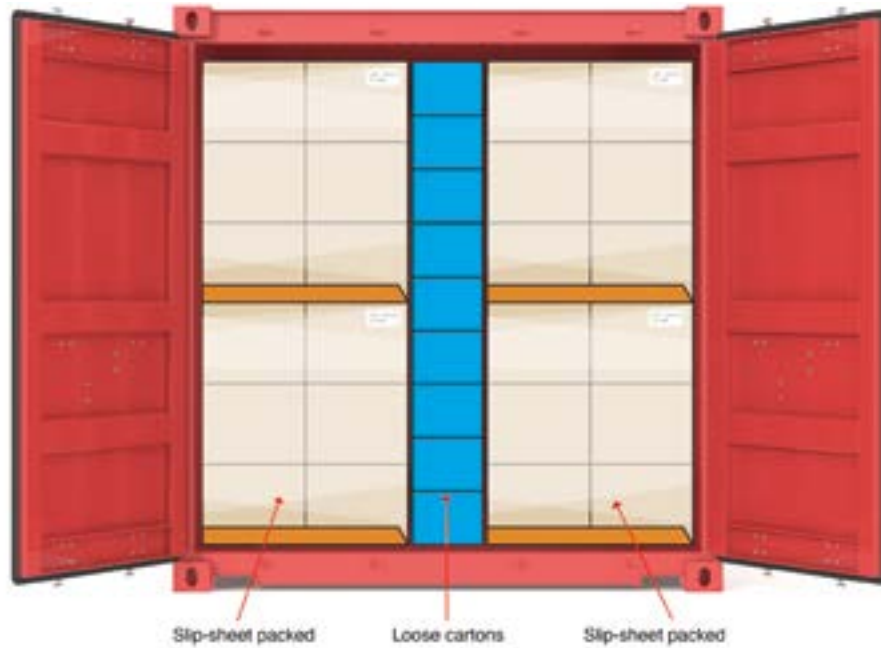

When all export cartons on slip-sheets have been loaded into the containers, the remaining space should be stuffed with loose export cartons to maximize the container loading. F&H requires all loose cardboard cartons to be placed in the middle and on the top as shown below. All cartons placed on the top must also be packed and wrapped with foil on slip-sheets containing only one item No. per sheet

When delivering on slip-sheets we require all cartons to be placed within the outer edges of the slip-sheets. If this is not followed, cartons might fall off during unloading.

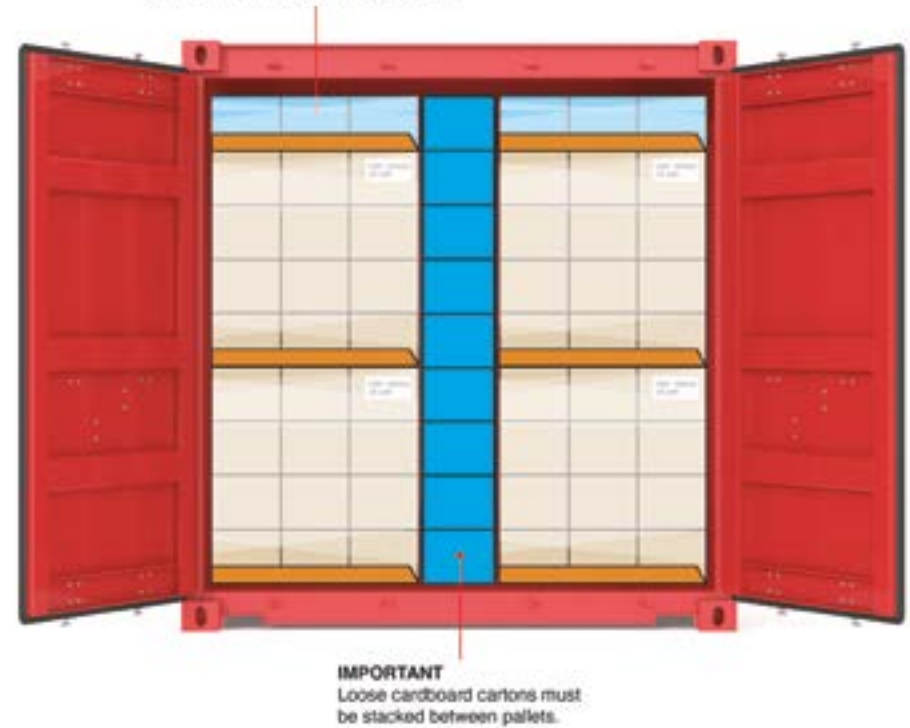

Figure 36: Example - how to load and stack loose cartons. Notice that the toplayer must be wrapped and placed on additional slip-sheets, containing only 1 itemnr.

7.2.5 F&H RECOMMENDATION

If you have any questions regarding pallet-boxes, you are very welcome to contact our office in Guangzhou on phone +86-20-89048075.

In the matrix below, the indicative number of shipping units is specified.

OSS = On slip-sheets

BULK = Bulk in container

Weight	Volume m ³	Export carton							
		Max 0,02	Max 0,04	Max 0,06	Max 0,08	Max 0,10	Max 0,15	Max 0,20	> 0,20
Max 3 kg		OSS	OSS	OSS	BULK	BULK	BULK	BULK	BULK
Max 5 kg		OSS	OSS	OSS	BULK	BULK	BULK	BULK	BULK
Max 7 kg		OSS	OSS	OSS	BULK	BULK	BULK	BULK	BULK
Max 10 kg		OSS	OSS	OSS	OSS	OSS	OSS	OSS	OSS
Max 12 kg		OSS	OSS	OSS	OSS	OSS	OSS	OSS	OSS
Number of shipping unit in 20* container - estimated		2800	1400	700	467	350	280	187	140

Slip-sheet dimensions

Max height 120 cm

Max width 80 cm

Max length 120 cm

OSS = On slip-sheet (Please see figure 34 on page 37)

OSS = Pallet box (Please see figure 40 on page 40)

*Must be wrapped with foil or carton to secure small boxes /or put into a pallet box.

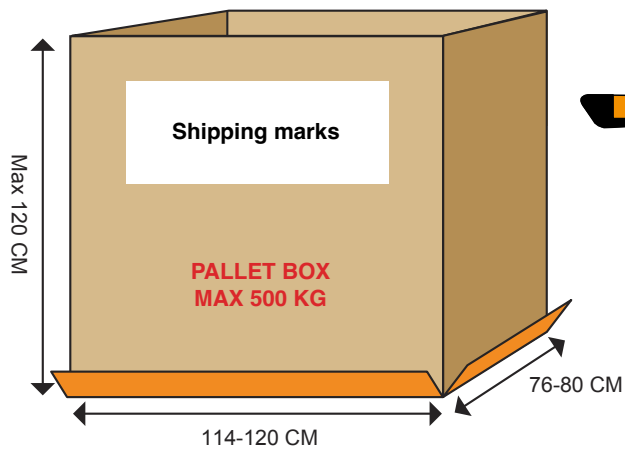

Figure 37: How to mark the palletbox.

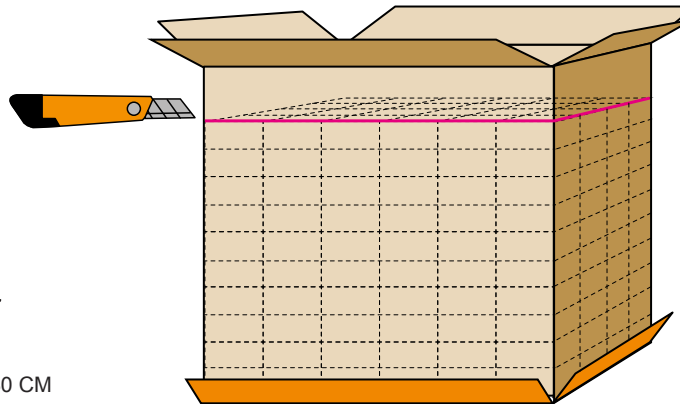

Figure 38: Cut pallet box down to fit the goods for better stability prior to stacking.

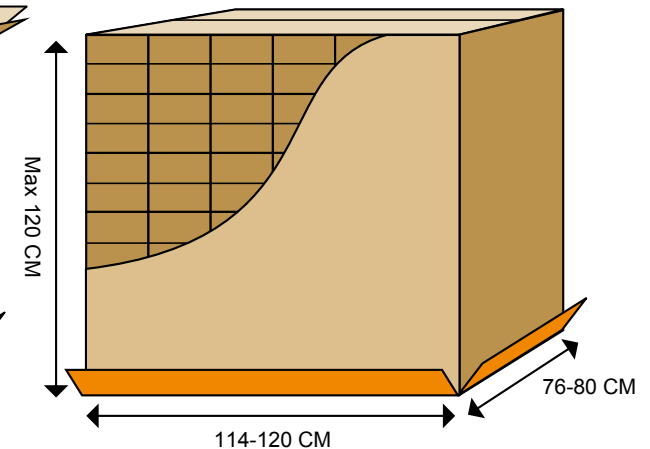

Figure 39: Sectional drawing showing the inside and outside of a palletbox.

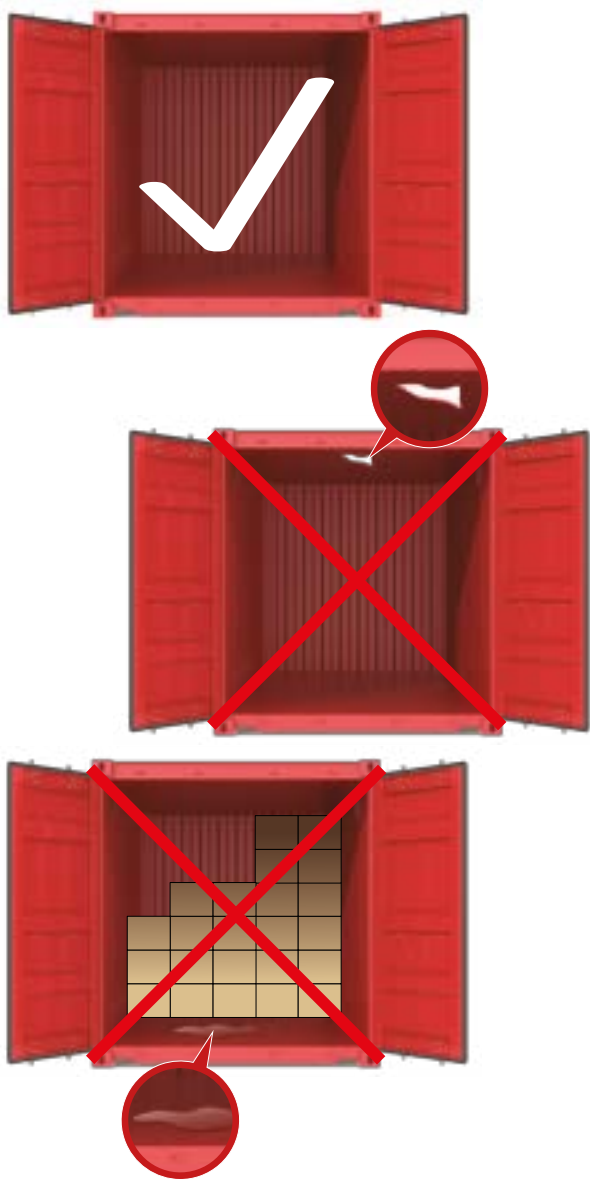

Figure 40: Only containers in good condition are accepted at F&H's terminals.

7.2.6 REDUCTION OF MOISTURE

To ensure the best possible conditions for the goods during transport, our suppliers should comply with the following points:

- Please make sure before packaging that the container is inspected and in good condition.
- Please check that there are no leaks in the roof, bottom or sides of the container.
- Prior to packaging please make sure that potential water or moist has been cleaned.

- Container, pallets and packaging materials must be dry before packaging begins, advantageous with humidity below 15%.
- All suppliers must upon request provide evidence for the moisture content of cartons used; therefore these should always be tested just prior to packing.
- During packing of the container, it should be ensured that this is done in a dry environment.



Figure 41: Do not load the container outside when conditions are wet/moist.

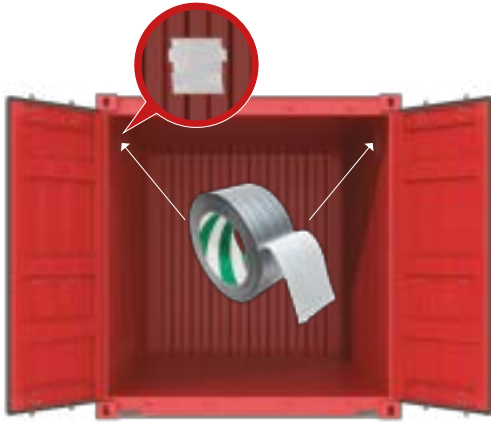

Figure 42: Sealing of container ventilation holes, applies only when using drybags.

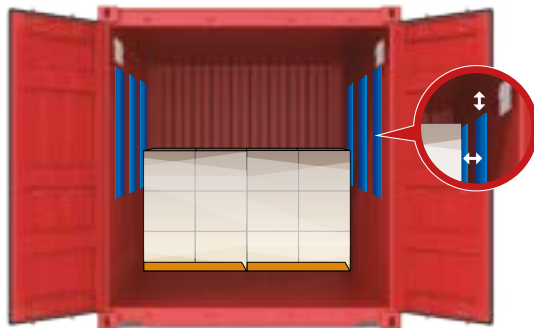

Figure 43: Example – where to place drybags

- **ONLY WHEN USING DRYBAGS;** To prevent further ingress of moisture in the container, the ventilation holes in the container should be sealed with tape.
- To prevent mold growth on products and cartons, drybags must be hung inside the container in the wet season. F&H has a requirement that from March 15th to November 15th drybags are to be used. We recommend 10 drybags in 20” containers or 20 drybags in 40” containers, evenly spaced.

7.2.7 TYPES OF DRYBAGS

There are various types of drybags available that can be used depending on your product types, packing methods and how full the container is. In all cases, F&H has a requirement that there should be a sufficient number of small drybags inside the carton to prevent mold and degradation of the product. These following products can be used for moisture reduction inside the containers:

Absortech Absorpole; requires 5 cm of space between the drybag and goods. It is easy to install and can be used if the product is stable and if the container is not completely filled.

Absorgel Hanging; requires 2.5 cm of space between the drybag and goods. It can be hung both vertically and horizontally, is easy to install and can be used in cases where the container is completely filled.

Absorgel Blanket; is placed on top of the product. It can therefore be used in the event that there are no hooks for hanging. It is easy to install and is particularly advantageous when space is tight, and the container is completely filled.

Drybags used must be by the manufacture “Absorgel”. If this brand or product cannot be obtained, drybags with similar characteristics and function can be used.

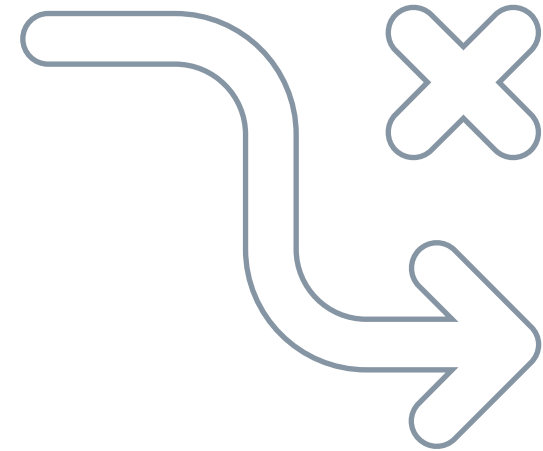

GENERAL INFORMATION REQUIRED UPON SHIPMENT

To ensure efficient communication between the supplier and F&H A/S, a complete shipping list must be mail to the Purchaser no later than on the day of shipment. The list must embed the following information:

8.1 GENERAL INFORMATION

1	F&H order number	
2	Container number	
3	Bill of lading number	
4	Name of vessel (ship)	
5	Date of departure	
6	Consignor/Shipper	
7	Consignor's/shipper's contact person	

8.2 INFORMATION ABOUT SHIPMENT

8	Total volume of shipment	
9	Total weight of shipment	
10	Total number of export cartons in shipment	
11	Delivered on pallets (Yes/no)? If yes no. of pallets	
12	Information about hazardous goods	

**The goods delivered pr. truckload must correspond with the supplied packing list.*

F&H
GROUP

GL. SKIVEVEJ 70 · DK-8800 VIBORG · TLF. +45 8928 1300 · INFO@FH-GROUP.DK · WWW.FH-GROUP.DK